

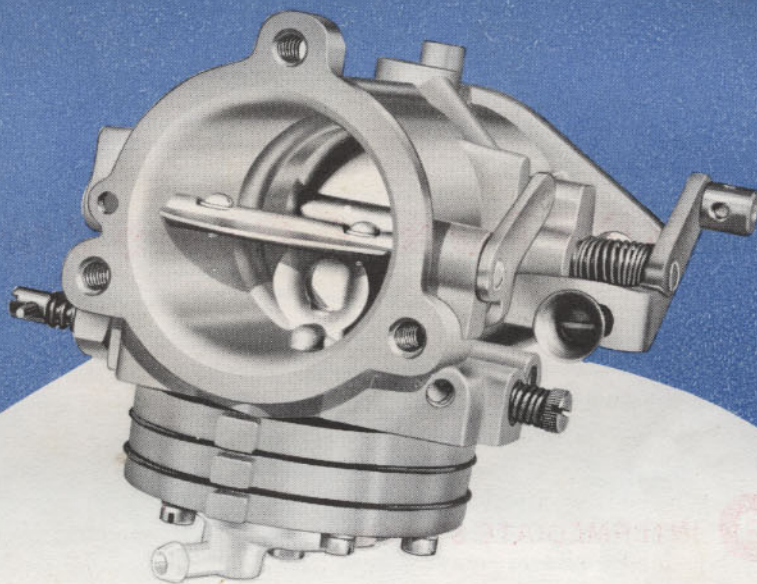

HD SERIES *Carburetor*



The Tillotson diaphragm series carburetors have been adopted as standard fuel systems on chain saw, snow vehicle, and industrial engines throughout the world. The HD series diaphragm carburetor has been developed by the Tillotson Manufacturing Company to make the advantages of a diaphragm carburetor available for use on larger engines having displacements of from 20 to 40 cubic inches per cylinder. The smaller carburetor features of construction simplicity, vibration resistance, tilt ability and easy servicing have been maintained and a more sophisticated fuel metering system has been added.

It is available as a complete fuel system consisting of a carburetor, integral fuel pump and fuel filter for use on two stroke cycle engines, as a carburetor, integral fuel filter and optional positive action accelerating pump for use on four stroke cycle engines,

or as a carburetor for use on two or four stroke cycle engines.

These special additional features have maintained the dependability and easy servicing characteristics of the smaller Tillotson carburetors that have been in use throughout the world for several years.

The information contained in the following pages is presented as an aid to understanding the construction, operation and servicing of the HD series carburetor.

The diaphragm controlled metering system allows precise fuel metering to the engine at extreme tilt angles and prevents fuel level changes due to vibration. The important feature of this part of the carburetor operation is that the amount of fuel going into the carburetor metering chamber is equal to the amount of fuel being used by the engine at any given time. There is no reservoir of surplus fuel to spill out of the carburetor.

The dual venturi used in this model series multiplies the venturi pressure drop causing fine atomization of the fuel that is delivered from the main fuel nozzle. The fuel reaches the engine as a combustible fog instead of a fluid stream. This venturi system combined with the automatic power valve can produce increased power and fuel economy.

IF FURTHER DATA IS REQUIRED, PLEASE CONTACT

Tillotson[®]

DIVISION OF



761-769 BERDAN AVENUE

TOLEDO, OHIO 43612

HD SERIES

SERVICE MANUAL

CARBURETOR ADJUSTMENT

The high speed and idle mixture screws have normal right hand screw threads. These adjustments are turned clockwise to close, or lean the mixture, and counter-clockwise to open, or enrichen the mixture. The starting adjustment opening for a new unit, or a carburetor that has not been run on the engine, is one full turn open on both the high speed and idle mixture screws.

The idle speed screw should be adjusted to open the throttle shutter a small amount. This adjustment should be carefully made on vehicles that have a centrifugal clutch drive arrangement; a very high idle speed may cause the clutch to engage and the vehicle may start to move.

Open the fuel line shut off valve, if your engine is equipped with one, and close the choke shutter. Open the throttle about one quarter of full travel and firmly pull the starting cord until the engine fires. Open the choke shutter far enough to allow the engine to idle until it has warmed up enough to run continuously with the choke fully open. Do not race a cold engine.

Adjust the idle mixture screw to obtain a smooth, steady idle, and re-adjust the idle speed screw to obtain the idle speed recommended by the engine manufacturer. Re-check

the idle mixture adjustment at the recommended idle speed. An over rich idle mixture will cause the engine to fire unevenly and there will be smoke from the exhaust. A lean idle mixture will usually cause backfiring.

The high speed mixture screw should be adjusted with the engine at fully open throttle and under normal full load. The mixture should be adjusted to allow the engine to operate at highest RPM. The speed will decrease with either an over rich mixture or lean mixture.

The above procedure need not be repeated each time the engine is started. The adjustments will remain in position and will not require frequent re-adjustment.

After the carburetor has been correctly adjusted, the engine should start easily. To start a cold engine, close the choke shutter, open the throttle about one quarter of full travel, firmly pull the starting cord until the engine starts, open the choke far enough to allow the engine to idle until it has warmed up and can run continuously with the choke fully open.

To start a warm engine, pull the starting cord. It should not be necessary to use the choke unless the engine is overheated and fuel vapor is present in the fuel lines.

... DO NOT FORCE MIXTURE SCREWS INTO THEIR SEATS!

(If the engine fails to start, see the Trouble Data Section.)

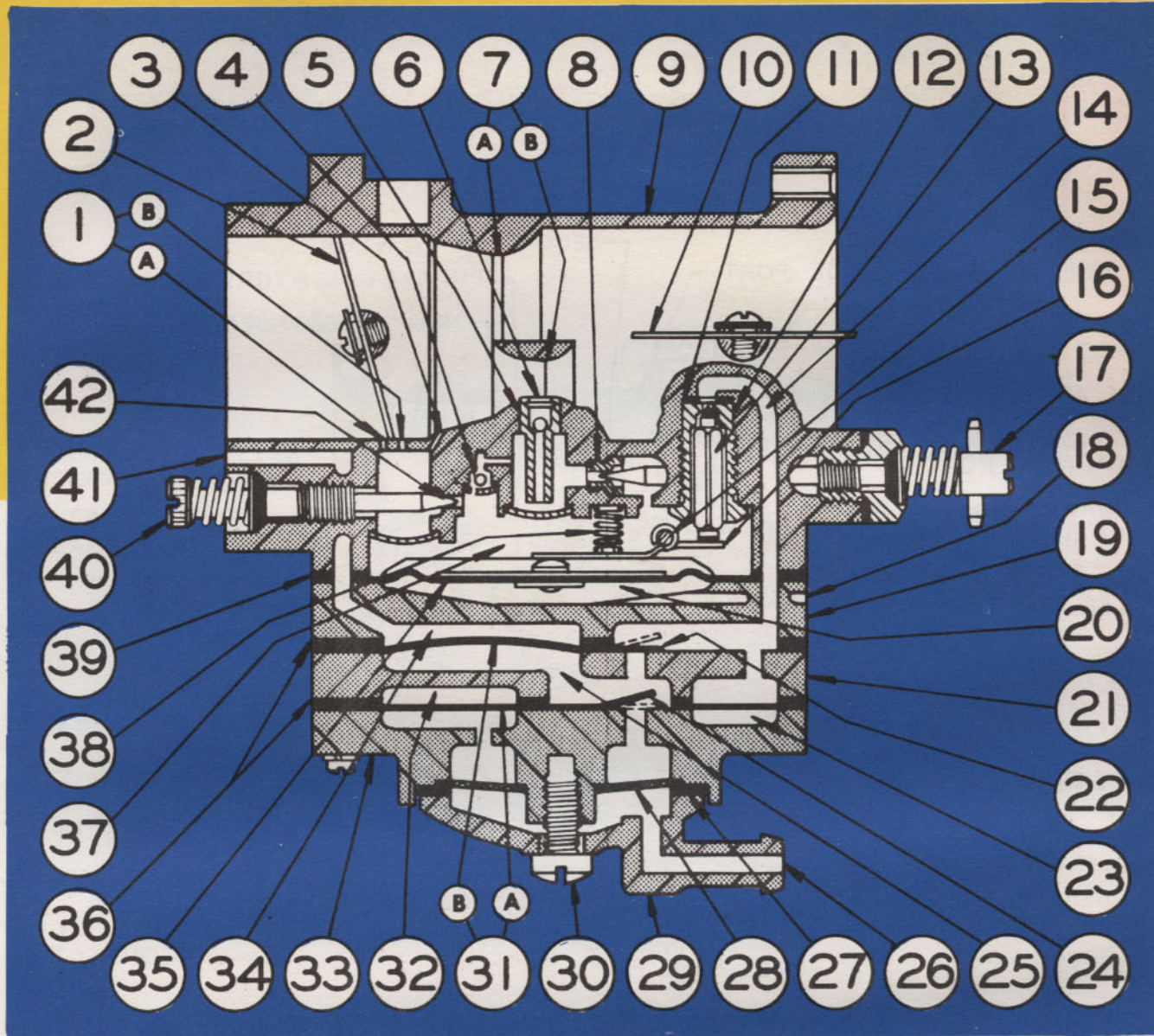

HD SERIES CARBURETOR NOMENCLATURE

- | | |
|----------------------------------|-----------------------------------|
| 1A PRIMARY IDLE DISCHARGE PORT | 22 PUMP OUTLET CHECK VALVE |
| 1B SECONDARY IDLE DISCHARGE PORT | 23 OUTLET SURGE CHAMBER |
| 2 THROTTLE SHUTTER | 24 PUMP INLET CHECK VALVE |
| 3 IDLE AIR BLEED | 25 FUEL PUMP CHAMBER |
| 4 POWER VALVE | 26 FUEL INLET |
| 5 MAIN FUEL CHECK VALVE | 27 STRAINER COVER GASKET |
| 6 MAIN FUEL DISCHARGE PORT | 28 FUEL STRAINER SCREEN |
| 7A SECONDARY VENTURI | 29 STRAINER COVER |
| 7B PRIMARY VENTURI | 30 STRAINER COVER RETAINING SCREW |
| 8 HIGH SPEED FUEL ORIFICE | 31A PUMP INLET VALVE DIAPHRAGM |
| 9 CARBURETOR BODY | 31B PUMP DIAPHRAGM |
| 10 CHOKE SHUTTER | 32 INLET SURGE CHAMBER |
| 11 INLET SEAT GASKET | 33 FUEL PUMP COVER |
| 12 INLET SEAT | 34 PUMP PULSE CHAMBER |
| 13 INLET NEEDLE | 35 METERING DIAPHRAGM |
| 14 FUEL INLET SUPPLY CHANNEL | 36 FUEL PUMP GASKETS |
| 15 FULCRUM PIN | 37 METERING CHAMBER |
| 16 INLET CONTROL LEVER | 38 INLET TENSION SPRING |
| 17 HIGH SPEED MIXTURE SCREW | 39 METERING DIAPHRAGM GASKET |
| 18 ATMOSPHERIC VENT | 40 IDLE MIXTURE SCREW |
| 19 METERING DIAPHRAGM COVER | 41 FUEL PUMP PULSE PORT |
| 20 ATMOSPHERIC CHAMBER | 42 IDLE FUEL ORIFICE |
| 21 PUMP BODY | |

SEE
FOLLOWING
PAGES FOR
OPERATIONAL
DATA



CARBURETOR

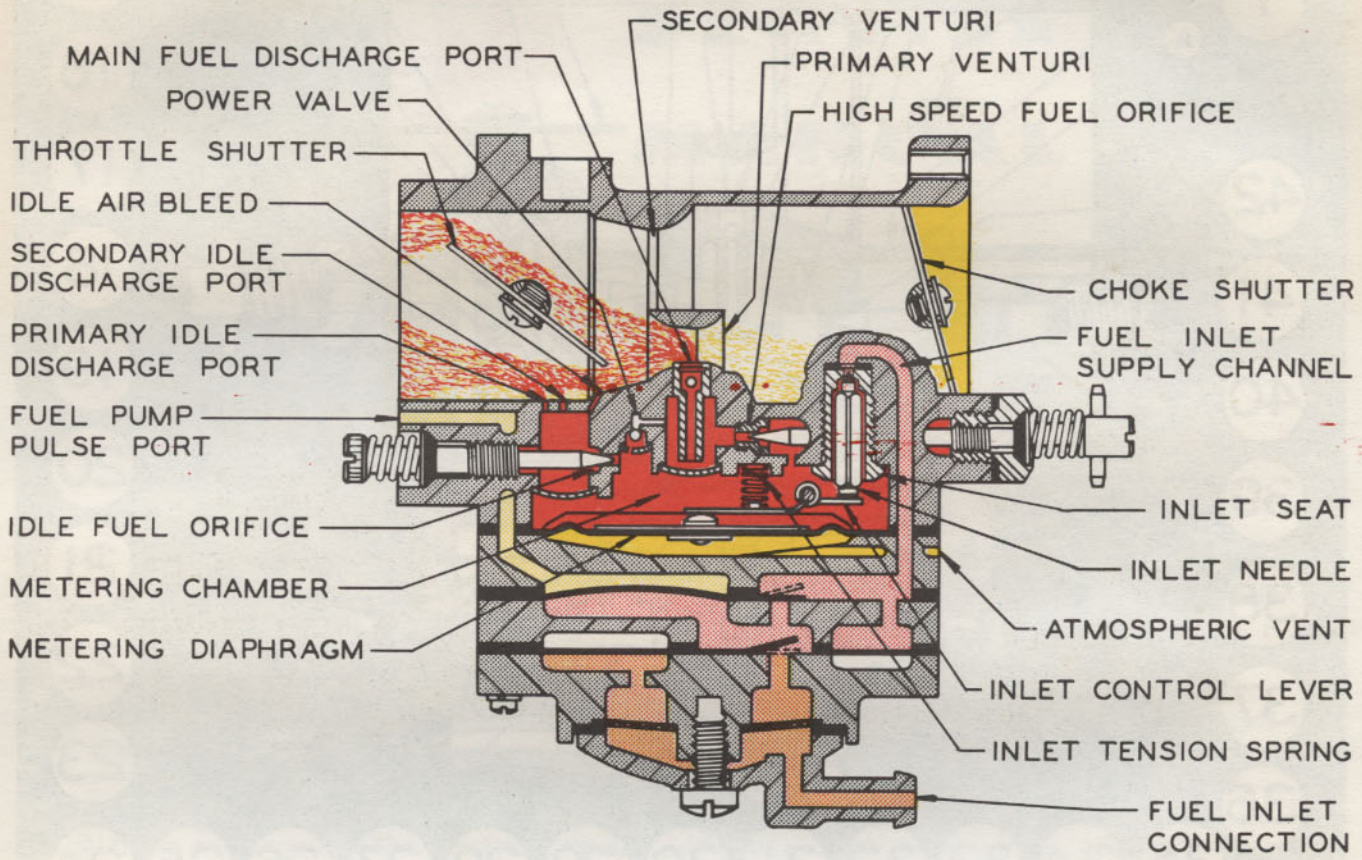





STARTING (CHOKE) OPERATION

Starting an engine that is equipped with the model HD carburetor involves the same methods that are used with the conventional float type carburetor. As the engine is cranked with the choke in the closed position, engine suction will be transmitted to the metering chamber through both primary and secondary idle discharge ports as well as the main fuel discharge port, creating a low pressure on the fuel side of the metering diaphragm. Atmospheric air pressure on the opposite or dry side will force the metering diaphragm upward causing the diaphragm button to contact the inlet control lever and overcome the inlet tension spring

pressure, permitting fuel pressure to force the inlet needle off its seat allowing fuel to enter the metering chamber. The fuel then travels from the metering chamber through the idle and main fuel supply orifices and channels to the discharge ports, into the carburetor bore and to the engine.

Fuel is delivered from all of the discharge ports when the choke is closed, providing a full, rich mixture for starting. A small amount of air is added to the rich mixture through a hole or port in the choke shutter.

-  SUPPLY FUEL
-  FUEL UNDER PRESSURE
-  FUEL UNDER VACUUM
-  ATMOSPHERIC AIR
-  PUMP IMPULSE AIR

OPERATIONAL DATA

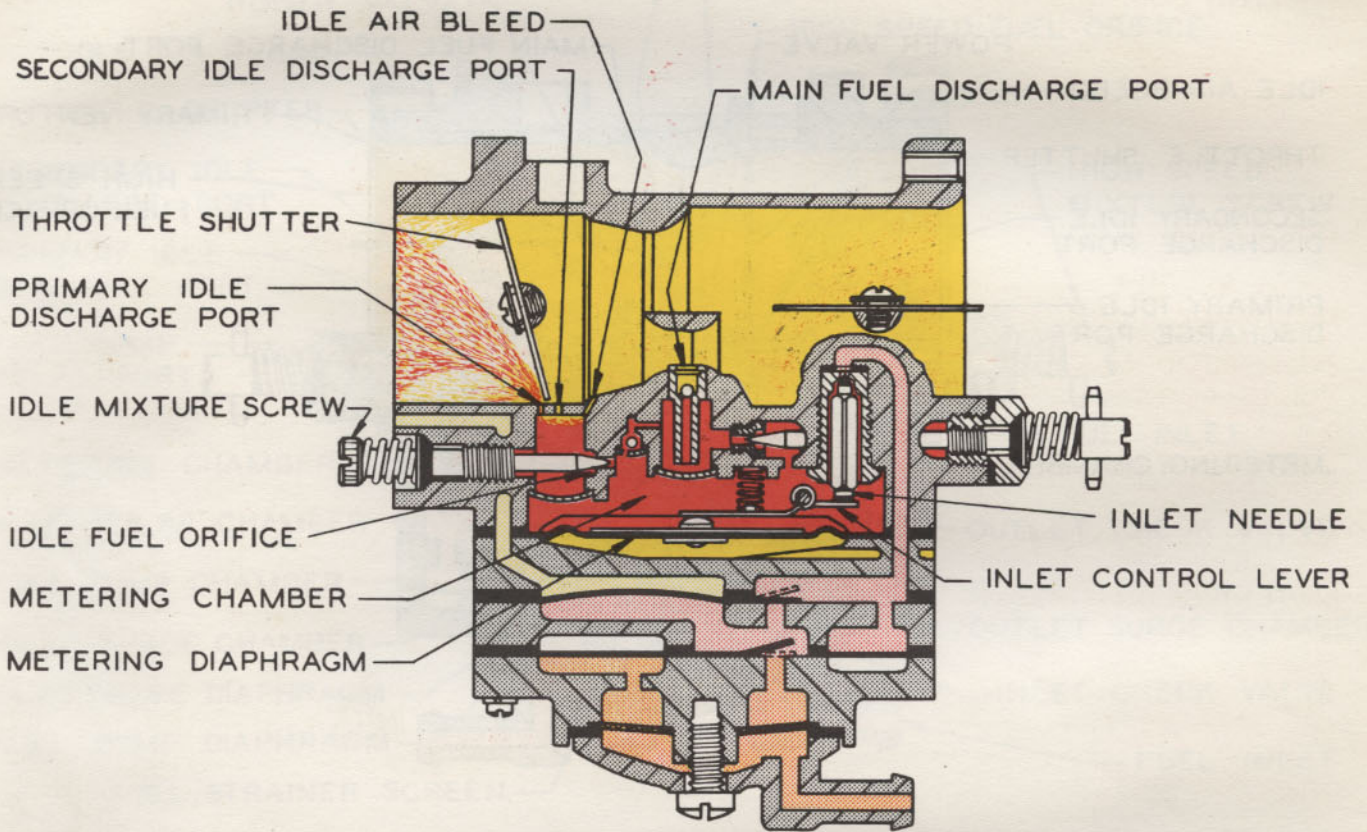

IDLING OPERATION

The throttle shutter is slightly open when the engine is idling. Engine suction is transmitted to the metering chamber through the primary idle discharge port and the idle fuel orifice. As in the starting operation, the metering diaphragm is forced upward by atmospheric pressure, depressing the inlet control lever, permitting fuel pressure to force the inlet needle off its seat, allowing fuel to enter the metering chamber. The fuel travels through the idle fuel orifice and is delivered to the engine through the primary idle discharge port. Air from the idle air bleed and secondary idle discharge port is mixed with the fuel before it is delivered from the primary discharge port.

The entire carburetor bore from the air inlet to the throttle shutter is at atmospheric pressure during idle operation. The ball check valve in the main fuel discharge port is closed to prevent air from entering the metering chamber. The atmospheric pressure at the outlet of the ball check valve and the metering chamber vacuum at the inlet of the ball check produces the force that keeps the ball on the seat even in an inverted position.

In all phases of operation, the amount of fuel entering the carburetor metering chamber is equal to the amount of fuel being used by the engine at any given instant.

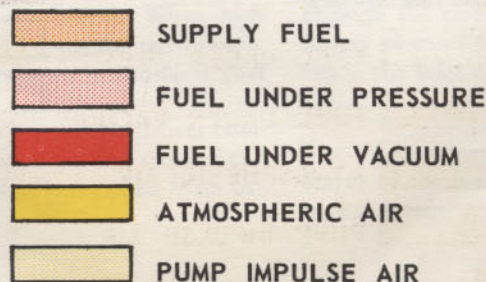

HD CARBURETOR

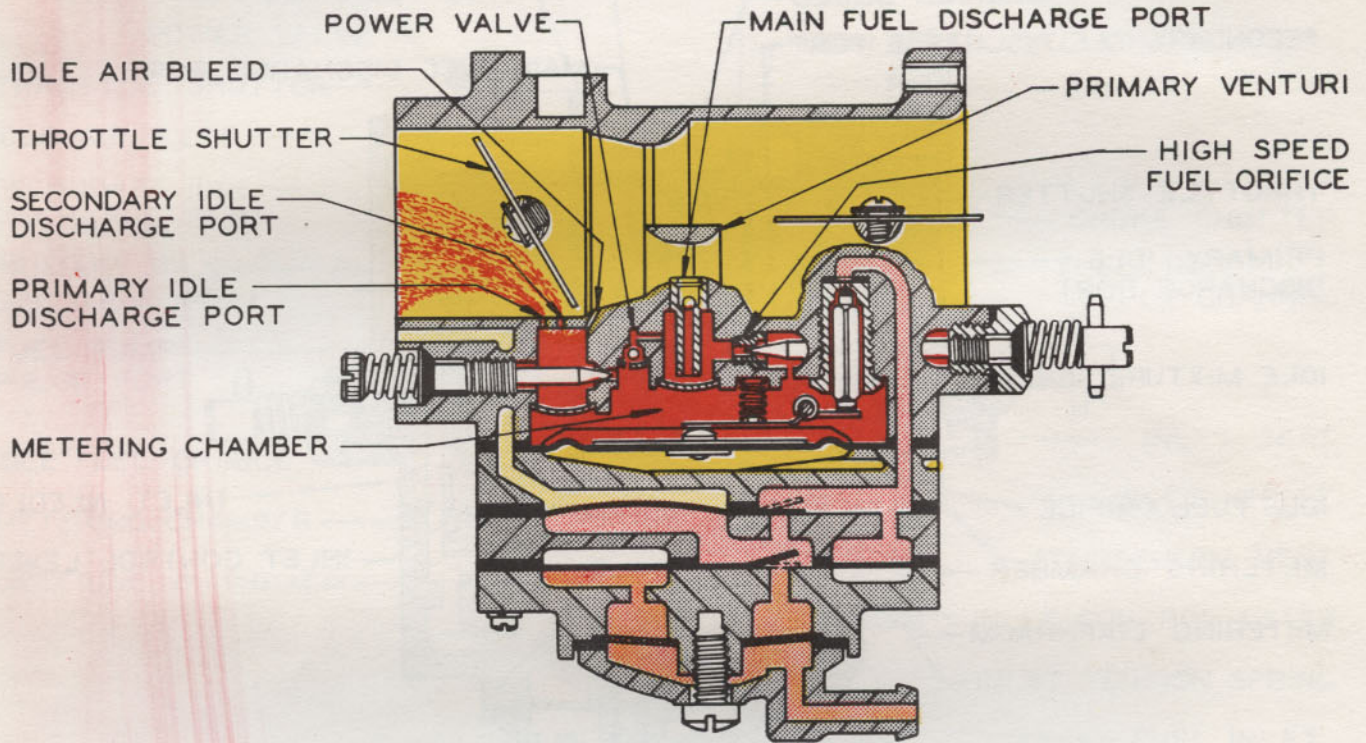





INTERMEDIATE OPERATION

Fuel is delivered into and through the carburetor in the same manner as when the engine was idling. However, as the throttle opens and engine speed increases, additional fuel is required from the carburetor and is supplied to the engine from the secondary idle discharge port which is located behind the primary idle discharge port. Air from the idle air bleed is mixed with the fuel before it is delivered from the primary and secondary idle discharge ports.

As the throttle shutter continues to open and the engine speed increases, the velocity of the air passing through the primary venturi increases to create a low pressure area in the primary venturi throat. When the pressure at the main fuel discharge port in the primary venturi is less than the pressure within the metering chamber, fuel flows through the high speed fuel orifice and out the main fuel discharge port.

Fuel is also supplied to the main fuel discharge port from the power valve during intermediate speed operation. The power valve adds fuel to the high speed fuel system for acceleration at part throttle conditions and automatically closes at high speeds when fuel from the high speed fuel orifice can provide adequate fuel for an economical mixture.

-  SUPPLY FUEL
-  FUEL UNDER PRESSURE
-  FUEL UNDER VACUUM
-  ATMOSPHERIC AIR
-  PUMP IMPULSE AIR

OPERATIONAL DATA

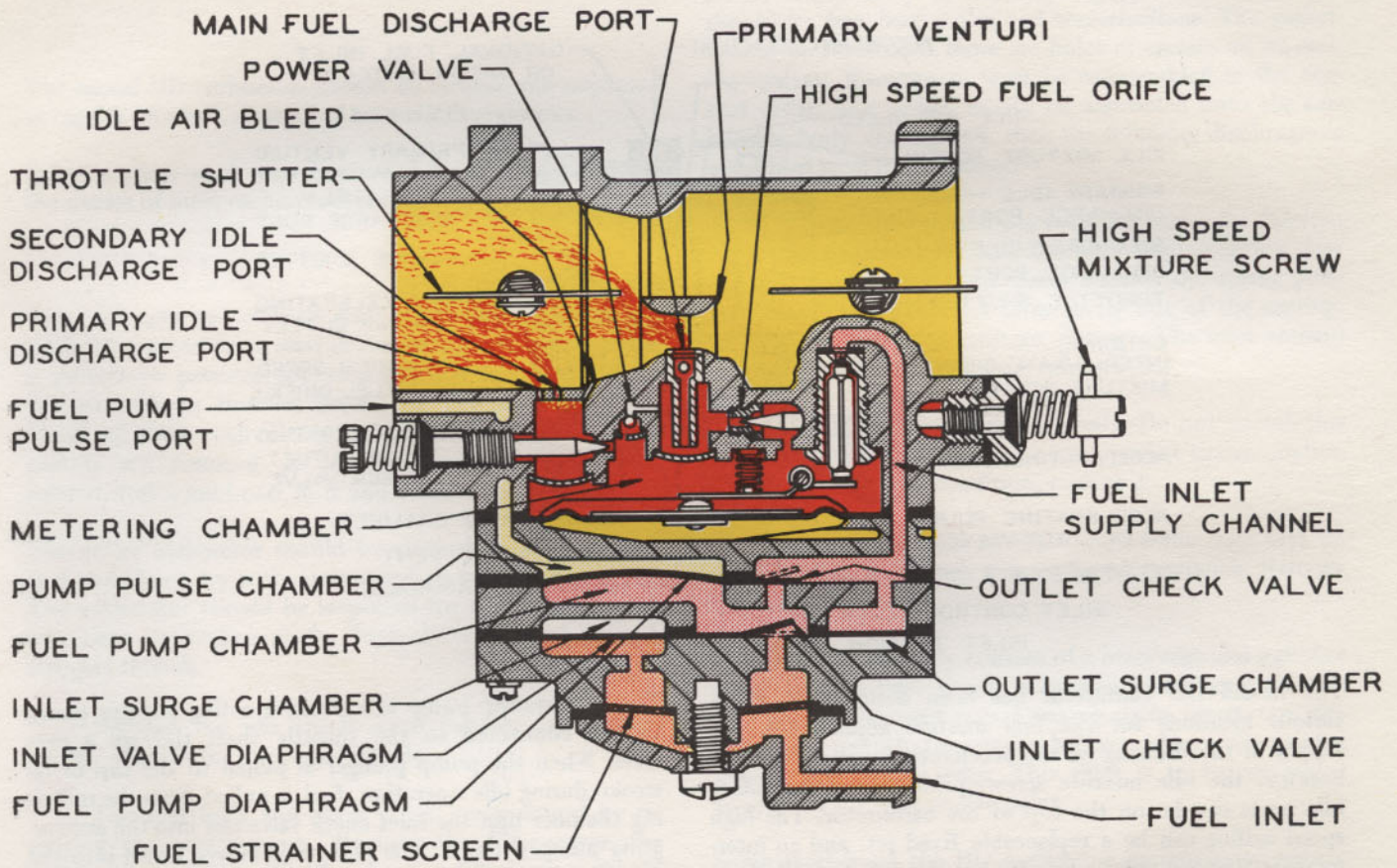

HIGH SPEED OPERATION

As the throttle shutter progressively opens from the intermediate position to fully open throttle, the velocity of air passing through the primary venturi increases and fuel is metered through the high speed fuel orifice and main fuel discharge port in sufficient quantity to satisfy the power requirement of the engine. The power valve is closed during high speed fully open throttle operation and the amount of fuel flowing from the main fuel discharge port is determined by the position of high speed mixture screw.

In the operating condition of fully open throttle and low engine speed, the power valve will deliver fuel to the main fuel discharge port to provide the rich mixture needed for this full load lugging operation. This is an operating situation such as running a vehicle on a steep slope where the vehicle moves slowly at fully open throttle. When high speed is resumed, as at the end of the slope, the power valve will automatically close to maintain an economical fuel mixture.

The primary and secondary idle discharge ports deliver comparatively little fuel at fully open throttle and most of the fuel used in this operating condition is supplied from the main fuel discharge port.

FUEL PUMP OPERATION

The fuel pump is a pulse operated diaphragm pump. The pressure-vacuum pulse is supplied from the engine crankcase where the pulse cycles are created by the reciprocating action of the engine piston. Crankcase pulse is transmitted to the pump pulse chamber through the fuel pump pulse port. The vacuum part of the pulse cycle causes the fuel pump diaphragm to move into the pump pulse chamber creating a vacuum in the fuel pump chamber that allows fuel to flow from the fuel inlet through the fuel strainer screen, past the inlet check valve and into the fuel pump chamber. The vacuum in the fuel pump chamber closes the outlet check valve during this part of the pumping cycle.

The pressure part of the pulse cycle forces the fuel pump diaphragm into the fuel pump chamber creating a pressure on the fuel that forces it out of the fuel pump chamber through the outlet check valve, and through the fuel inlet supply channel to the inlet needle valve. The fuel pressure closes the inlet check valve during this part of the pumping cycle.

The inlet and outlet surge chambers diminish the pressure surges of the fuel and provide steady fuel flow through the pump system.

OPTIONAL CONFIGURATIONS

... for the HD Model Carburetor

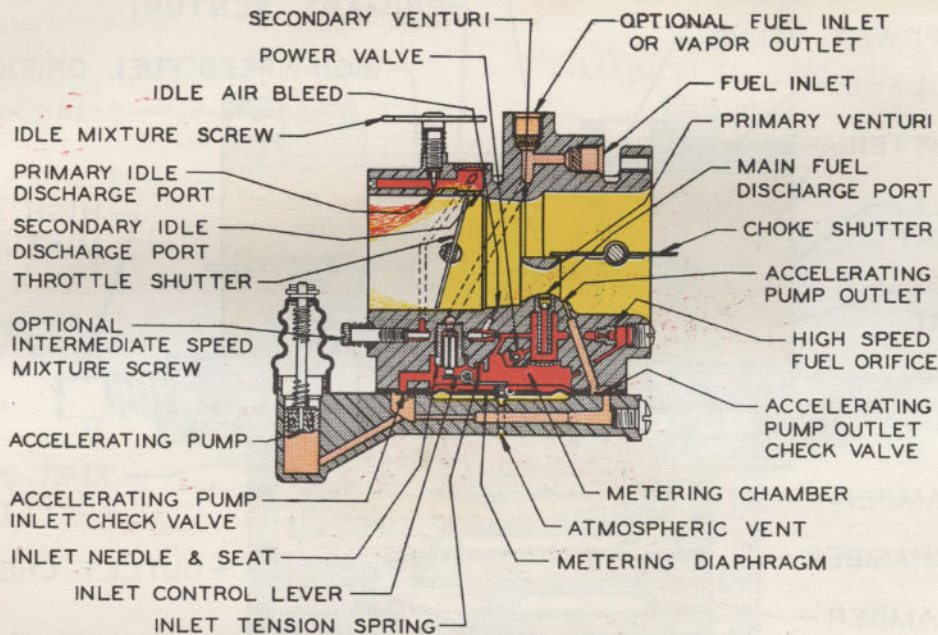

The model HD carburetor has been designed to allow various locations for the fuel mixture adjustments. As shown in the drawing of the accelerating pump type carburetor, the idle mixture screw, primary and secondary idle ports can be on the top of the carburetor. The high speed orifice can be a replaceable fixed jet, and an intermediate speed mixture screw can be added. Even with these changes the operation of the carburetor metering system and the fuel flow through the carburetor is the same as described on the previous pages.

The accelerating pump is a positive acting plunger pump that is connected to the throttle shaft through a cam lever. When the pump plunger is pulled to the top of its stroke during idle operation, fuel is pulled from the metering chamber past the inlet check valve and into the accelerating pump cylinder. The plunger is moved down into the pump cylinder during acceleration and fuel is pushed through the accelerating pump channels, past the outlet check valve and discharged into the air stream through the accelerating pump outlet.

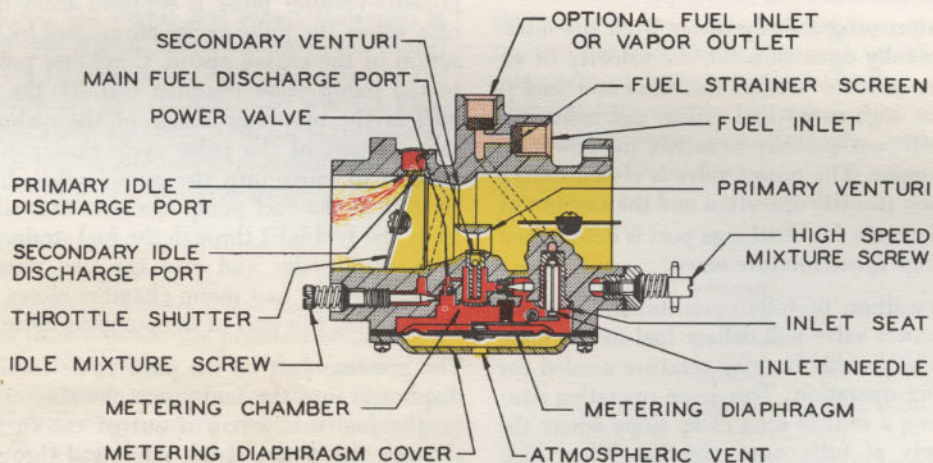

The model HD carburetor is also available with a plain diaphragm cover plate. The fuel must come from a separate fuel pump or an overhead fuel tank for a gravity fuel supply for these two optional models.

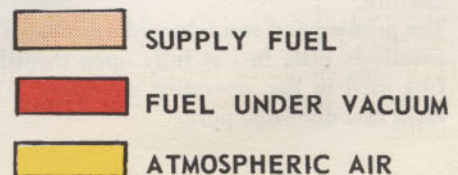

HOW to disassemble for cleaning and repair

The model HD carburetor should be cleaned and inspected at regular intervals, depending on service conditions.

Select a clean work area because dirt and carelessness are the causes of most carburetor trouble.

CAUTION:

Some solvents and cleaners have a damaging effect on the synthetic rubber parts used in carburetors. It is best to use a petroleum product for cleaning. Do not use alcohol, lacquer acetone thinner, benzol or any solvent with a blend of these ingredients unless the rubber parts and gaskets are removed. If you are in doubt about your solvent, test a used part in it and observe the reaction.

The entire carburetor should be cleaned by flushing with fuel and blown dry with compressed air before disassembly. The carburetor should be inspected for cracks in the casting, bent or broken shafts, loose levers or swivels and stripped threads.

1 Remove the idle speed screw, washer and tension spring. Inspect for damaged threads.

2 The fuel inlet and filter cover are removed by removing the center screw. Remove the filter cover, the cover gasket and the filter screen. The filter screen should be cleaned by flushing with fuel or solvent and blowing with compressed air. It is advisable to replace the gasket whenever the filter screen is serviced. Flush all dirt from the plastic cover before assembly.

3 Remove six body screws and the fuel pump cover casting. Inspect the casting for nicks, dents, or cracks that might interfere with operation. Remove the fuel pump inlet valve diaphragm and gasket. Inspect the diaphragm; it must be flat and free from holes. The gasket should be replaced if there are holes or creases on its sealing surface. Be certain to re-assemble these parts in the correct order. The pump gasket should be assembled onto the pump body first, then the fuel pump inlet valve diaphragm should be assembled next to the gasket so that the flap valves will seat against the fuel pump cover.

4 Remove the pump body casting, the pump diaphragm, and gasket. Inspect the diaphragm; it must be flat and free from holes. The gasket should be replaced if there are holes or creases on its sealing surface. Inspect the pump body casting for nicks, dents or cracks that might interfere with operation. Be certain to re-assemble these parts in the correct order. The pump gasket should be assembled onto the metering diaphragm cover first, then the pump diaphragm should be assembled next to the gasket so that the outlet flap valves will seat against the pump body casting.

5 Remove the metering diaphragm cover casting, the metering diaphragm and gasket. Inspect the cover casting for nicks, dents, or cracks that might interfere with operation. Inspect the metering diaphragm; the center plate must be riveted securely to the diaphragm and the diaphragm should be free from holes and imperfections. The gasket should be replaced if there are holes or creases on its sealing surface. These parts must be re-assembled in the correct order. The gasket should be assembled onto the carburetor body casting first, then the metering diaphragm is assembled next to the gasket.

6 Remove the fulcrum pin retaining screw, the fulcrum pin, inlet control lever and the inlet tension spring. Use caution in removing these parts because the spring pressure may cause the inlet lever to fly out of the casting. Inspect the parts for wear or damage. The inlet control lever must rotate freely on the fulcrum pin.

7 Handle the inlet spring carefully. Do not stretch this spring or in any way change its compression characteristics. If in doubt about its condition, replace it.

8 Remove the inlet needle. Remove the inlet seat assembly using a 3/8-inch thin wall socket wrench. Remove the inlet seat gasket.

The inlet seat assembly consists of a brass cage and a rubber insert for the inlet needle seat. The insert goes into the cage only one correct way. Looking at the insert, one side is flat and smooth; the other side has a ridge or rim molded around the outside edge. This ridge is to be assembled away from the inlet needle point.

Some models of the HD carburetor are equipped with a rubber tipped needle, a brass inlet seat and a copper gasket. The installation instructions below are applicable to both types of inlet seats.

The inlet needles and seats are matched and tested for leaks at the factory and the parts should not be interchanged - they must be kept in matched sets. When installing the insert cage into the carburetor body, use a new gasket. Do not force the cage, as you may strip the threads or distort the insert. Use a torque wrench to apply 40 to 50 inch-pounds torque. The needle and seat assembly must be clean to insure correct performance.

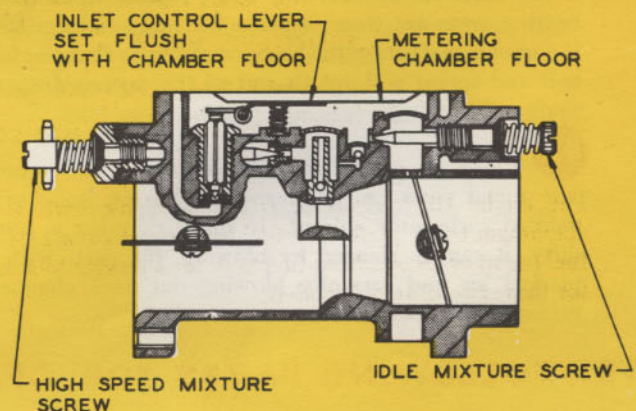

(Continued)

HOW TO DISASSEMBLE FOR CLEANING AND REPAIR

9 Remove and inspect the points of the high speed and idle mixture screws. Through misuse, either mixture screw point may be bent, extruded from being forced into the casting seat or possibly broken off in the casting. If either mixture screw is damaged, be sure to inspect the condition of the casting. If the adjustment seats are damaged, a new body casting is required.

10 The idle bypass ports and main nozzle ball check valve are sealed from the metering chamber by welch plugs. It is seldom necessary to remove either of these plugs because there is no wear in either section, and any dirt that may accumulate can usually be blown out with compressed air through the mixture screw holes. If the carburetor is unusually dirty and the welch plugs must be removed, it will require careful work. Drill through the welch plug, using an 1/8 inch drill. Allow the drill to just break through the welch plug. If the drill travels too deep into the cavity, the casting or the main nozzle ball check valve may be ruined. Pry the welch plug out of its seat, using a small punch.

Inspect the idle bypass holes to insure they are not plugged. Do not push drills or wires into the metering holes. This may alter carburetor performance. Blow plugged holes clean with compressed air. Remove the main nozzle ball check assembly by pressing it out of the casting into the primary venturi. If a new part is required, press the new assembly into the nozzle well so that the bottom surface of the ball cage is flush with the surface of the nozzle well. This is important because the nozzle pipe must be below the welch plug in order to receive an adequate supply of fuel. If this check ball is defective, the engine will not idle unless the high speed mixture screw is shut off. Replace the defective part.

11 The choke and throttle shafts may be removed if there is evidence of wear on these parts. The shafts do not have to be removed before cleaning the body casting if the parts are not worn.

Mark the throttle and choke shutters before removing them so that they can be re-assembled correctly. The edges are tapered for exact fit into the carburetor bores. Remove two screws and pull the shutter out of the carburetor body. Remove the throttle shaft clip and pull the shaft out of the casting. Examine the shaft and the body bearings for wear. If the shaft shows excessive wear, replace it. If the body bearing areas are worn, replace the body casting. Remove the choke shaft from the body carefully so that the friction ball and spring will not fly out of the casting. Inspect the shaft and bushings.

12 Clean all parts before re-assembling the carburetor. The metal parts can be cleaned in a good grade of commercial carburetor solvent. If the carburetor is not very dirty, it can be cleaned by blowing the parts with compressed air and carefully blowing out each channel and orifice in the castings.

REPLACE ALL WORN PARTS

13 Assemble the carburetor. Make certain that all parts are kept clean before they are assembled to the body casting. Few measurements are required to complete the assembly of this simple unit:

- a) Tighten the inlet seat to 40-50 inch-pounds of torque.
- b) Adjust the inlet control lever so that the center of the lever that contacts the metering diaphragm is flush to the metering chamber wall as shown in the drawings.
- c) Install new welch plugs at the nozzle well and bypass chamber if the original parts were damaged or removed. Place the new welch plug into the casting counter bore convex side up and flatten it to a tight fit, using a 5/16 inch flat end punch. If the installed welch plug is concave, it may be loose and cause an uncontrolled fuel leak. The correctly installed welch plug is flat.
- d) Assemble the gaskets, diaphragms and castings in the correct order.
- e) Assemble the throttle shaft into the carburetor body and attach the throttle shaft clip before assembling the throttle shutter. With the shaft secured in place, assemble the shutter into the shaft. Make certain that the shutter fits accurately into the throttle bore in the closed position.
- f) Assemble the spring and ball into the choke shaft hole and assemble the shaft into position. Assemble the shutter into the choke shaft. Make certain that the choke shutter fits tightly to the carburetor bore in the closed position.

14 A carefully rebuilt HD model carburetor should perform well. The two most likely causes of carburetor failure are dirt and a careless repair job. A clean, carefully assembled unit should be nearly as good as new.

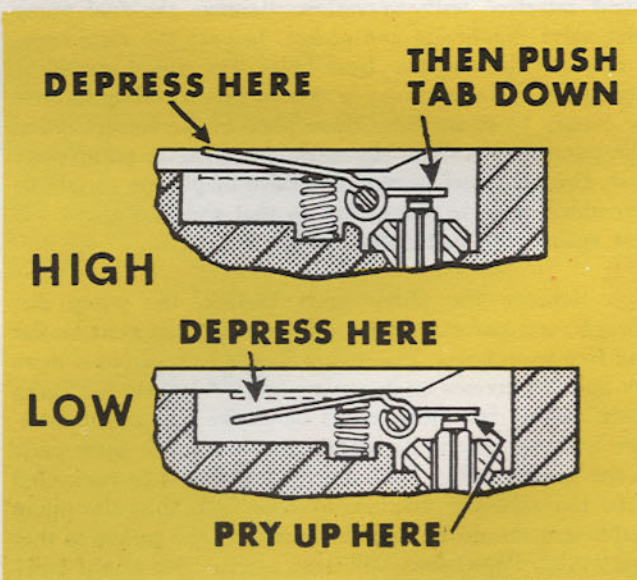

SEE FOLLOWING PAGES FOR OPERATIONAL Trouble and Remedy Data

...TROUBLE SHOOTING

The following symptoms and possible causes with corrective service recommendations can be used as a guide in servicing the Model HD carburetor.

A IDLE SYSTEM

1. IDLE OPERATION TOO LEAN

- a) Adjustment set too lean – *Readjust*
- b) Dirt in idle fuel channels – *Blow out with compressed air*
- c) Channel plugs missing or not tightly sealed – *Re-seat or replace channel plugs*
- d) Main fuel check valve not sealing – *Blow out with compressed air or replace*
- e) Inlet control lever set too far away from diaphragm – *Re-set control lever flush with metering chamber wall*

2. IDLE OPERATION TOO RICH

- a) Carburetor flooding – *See item E*
- b) Idle adjustment screw point damaged – *Replace the adjustment screw*
- c) Idle air bleed plugged – *Blow out with compressed air*
- d) Idle adjustment hole damaged, forced, over-size or casting cracked near the adjustment point – *Replace carburetor*

B INTERMEDIATE SYSTEM

1. LEAN OPERATION AT INTERMEDIATE SPEEDS

- a) Adjustment set too lean – *Readjust*
- b) Dirt in intermediate fuel ports or supply channels – *Blow out with compressed air*
- c) Channel plugs missing or not tightly sealed – *Re-seat or replace channel plugs*
- d) Main fuel check valve not sealing – *Blow out with compressed air or replace*
- e) Power valve ball stuck closed – *Remove welch plug and steel ball and blow out channel with compressed air*
- f) Inlet control lever incorrectly set – *Readjust inlet control lever*

2. RICH OPERATION AT INTERMEDIATE SPEEDS

- a) Adjustment set too rich – *Readjust*
- b) Carburetor flooding – *See item E*
- c) Main fuel check valve welch plug not tightly sealed – *Re-seat or replace*
- d) Choke valve partially closed – *See that choke friction spring and ball are correctly assembled*
- e) Inlet control lever incorrectly set – *Readjust inlet control lever flush with metering chamber wall*

C MAIN NOZZLE SYSTEM

1. LEAN OPERATION AT HIGH SPEEDS

- a) Adjustment set too lean – *Readjust*
- b) Dirt in nozzle system – *Blow out channels with compressed air*
- c) Adjustment packing damage – *Replace packing*

- d) Main fuel check valve damaged – *Replace*
- e) Main fuel check valve not seated correctly in body casting – *Re-seat the assembly flush with nozzle well surface*
- f) Inlet control lever incorrectly set – *Readjust inlet control lever flush with metering chamber wall*

2. RICH OPERATION AT HIGH SPEEDS

- a) Adjustment set too rich – *Readjust*
- b) Carburetor flooding – *See item E below*
- c) Power valve ball check not seating – *Remove welch plug and steel ball and blow out channel with compressed air*
- d) Inlet control lever incorrectly set – *Readjust inlet control lever flush with metering chamber wall*

D ACCELERATING PUMP SYSTEM

1. LEAN ACCELERATION

- a) Incorrect adjustment – *Readjust*
- b) Dirt in acceleration fuel channels – *Blow out all channels in the metering diaphragm cover and the accelerating pump outlet in the carburetor body*
- c) Accelerating pump assembly damaged or worn – *Replace this assembly*
- d) Diaphragm cover plug screw loose or missing – *Tighten or replace*
- e) Power valve ball check stuck closed – *Remove welch plug and steel ball and blow channel clean with compressed air*

E CARBURETOR FLOODING

- 1. Dirt in inlet needle and seat assembly – *Remove and clean or replace*
- 2. Inlet seat gasket missing or damaged – *Replace gasket*
- 3. Inlet control lever incorrectly adjusted – *Readjust lever flush with metering chamber wall*
- 4. Diaphragm incorrectly installed – *Replace or correct installation*
- 5. Inlet control lever pin loose or not correctly installed – *Tighten retaining screw and correct installation*
- 6. Inlet control lever tight on fulcrum pin – *Replace damaged part or clean dirt from these parts*
- 7. Inlet needle or seat damaged or worn – *Replace the assembly*

NOTE- *If flooding persists, clean the fuel tank and fuel lines.*

...Continued on back page...

TROUBLE SHOOTING (Continued)

F GENERAL OPERATION

1. LEAN OPERATION IN ALL SPEED RANGES

- a) Filter screens plugged or dirty – *Clean or replace*
- b) Inlet control lever incorrectly adjusted – *Readjust lever flush with wall of metering chamber*
- c) Diaphragm cover plates loose – *Tighten screws*
- d) Air leak into the metering system – *All channel plugs, plug screws and lead plugs to be tightly sealed*
- e) Inlet tension spring stretched or damaged – *Replace spring*
- f) Fuel pump not operating – *Clean fuel pump and replace worn parts or check assembly to be certain that gaskets and diaphragms are correctly installed*

- g) Carburetor loose on manifold – *Tighten in place*
- h) Air leak in fuel lines – *Replace fuel line*
- i) Fuel line plugged – *Clean fuel line*
- j) Low fuel supply – *Fill fuel tank*
- k) Pump pulse channel plugged or not aligned to engine – *Clean or correct alignment*
- l) Fuel tank vent not operating – *Repair vent*

2. RICH OPERATION IN ALL SPEED RANGES

- a) Ruptured pump diaphragm – *Replace diaphragm*
- b) Carburetor flooding – *See item E (page 11)*
- c) Welch plugs not sealing – *Re-seat or replace*
- d) Inlet control lever incorrectly set – *Readjust lever flush with wall of metering chamber*
- e) Plugged air filter – *Clean or replace*



IF FURTHER DATA IS REQUIRED, PLEASE CONTACT

Tillotson® DIVISION OF **BORG WARNER**®

761-769 BERDAN AVENUE

• TOLEDO, OHIO 43612